

QUADRANT – UNLIT 4232U

PROJECT PROJET
SPEC TYPE
NOTES

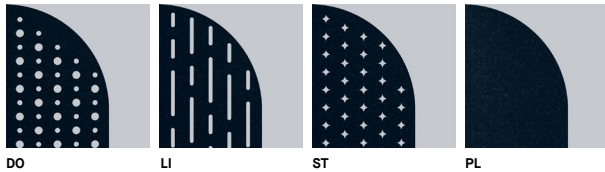

CUTOUT PATTERN MOTIF DÉCOUPÉ



FELT FINISH FINI FEUTRE



ADDITIONAL PREMIUM COLORS AVAILABLE – SEE ACOUSTIC MATERIAL COLOR OPTIONS PAGE

FAMILY FAMILLE



4232

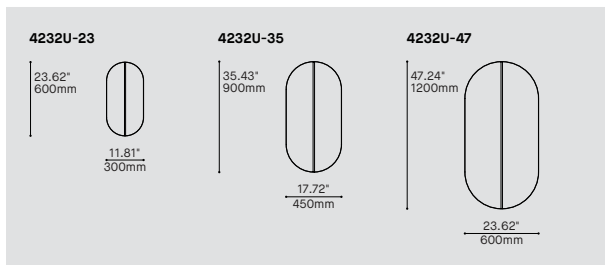

ORDERING SPECIFICATION SPÉCIFICATION DE COMMANDE

CODE

MODEL MODÈLE					
4232U-23	SMALL QUADRANT UNLIT				
4232U-35	MEDIUM QUADRANT UNLIT				
4232U-47	LARGE QUADRANT UNLIT				
FELT FINISH FINI FEUTRE					
ABF	AZURE BLUE FELT	BYF	BANANA YELLOW FELT	REF	RED FELT
AWF	ARCTIC WHITE FELT	CHF	CHARCOAL FELT	SGF	SILVER GRAY FELT
BBF	BASIC BLACK FELT	NBF	NAVY BLUE FELT	TGF	TITANIUM GRAY FELT
BOF	BLOOD ORANGE FELT	OBF	OCEAN BLUE FELT	ZFF	ZINFANDEL FELT
BTF	BATTLESHIP GRAY FELT	PGF	PEAR GREEN FELT		
PREMIUM*	PLEASE SPECIFY PREMIUM COLOR CODE – SEE ACOUSTIC MATERIAL COLOR OPTIONS PAGE * LONGER LEAD TIME MAY APPLY, PLEASE CONTACT YOUR EUREKA REPRESENTATIVE				
CUTOUT PATTERN MOTIF DÉCOUPÉ					
DO	DOTS				
LI	LINES				
ST	STARS				
PL	PLAIN				
CABLE CÂBLE					
AC	AIRCRAFT MOUNTING, FIELD ADJUSTABLE				
CABLE LENGTH LONGUEUR DE CÂBLE					
60	60" AIRCRAFT CABLE (STD LENGTH)				
**	CUSTOM AIRCRAFT CABLE LENGTH (PLEASE SPECIFY) FOR OVERALL LENGTH, PLEASE CONTACT YOUR EUREKA REPRESENTATIVE				

PRODUCT CHARACTERISTICS CARACTÉRISTIQUES DU PRODUIT



- DESIGN:** Quadrant pendant highlights our discreet Mika 4230 diffuser by redefining its volume and scale. Lighted versions (4232) or the versions without light source (4232U) can be used alone or combined to create impressive layouts, while multiplying the sound absorption. Available in 3 sizes and with a variety of decorative cutout pattern made by a high precision cnc cutter.
- INSTALLATION:** Installs without tool onto our pendant Mika luminaires with an ingenious crisscross assembly system. Quadrant is suspended on a clear power cable with standard or slim magnetic canopy available in white fine textured finish, with no visible fastener. Quadrant unlit is suspended on an aircraft cable without canopy.
- SHADE:** The shade is composed of two rigid interlocked sound absorbing panels that increases acoustic comfort. They are made from synthetic felt composed of recycled and recyclable polyethylene (PET) fibers with low VOC, formaldehyde-free, non-irritant and odorless. c-CSA-us
- CERTIFIED:**
- CONCEPTION:** La suspension Quadrant met en valeur le discret diffuseur du Mika 4230 en redéfinissant son volume et son échelle. Les versions éclairées (4232) ou sans source lumineuse (4232U) peuvent s'utiliser seules ou être disposées de façon à créer d'impressionnant agencement, multipliant ainsi l'absorption du bruit ambiant. Disponible en 3 grandeurs et avec une variété de motifs décoratifs découpé par une machine CNC de haute précision.
- INSTALLATION:** S'installe sans outil sur les luminaires Mika grâce à un ingénieux système d'assemblage entrecroisé. Quadrant est suspendu sur câble d'alimentation clair, sans quincaillerie visible, monté sur un pavillon magnétique standard ou mince. Le Quadrant non-éclairé est suspendu par câble d'acier sans pavillon.
- ABAT-JOUR:** L'abat-jour du luminaire est composé de deux rigide panneaux insonorisant entrecroisés qui augmentent le confort acoustique. Ils sont fabriqués de feutre synthétique à base de fibres de polyéthylène (PET) recyclées et recyclables avec bas COV, sans formaldéhyde, non irritant et inodore.
- CERTIFIÉ:** c-CSA-us

QUADRANT – UNLIT 4232U

QUICKSHIP

PROJECT PROJET

SPEC TYPE

NOTES

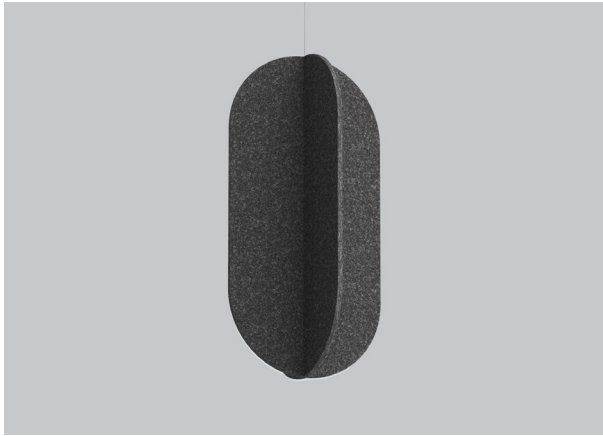

CUTOUT PATTERN MOTIF DÉCOUPÉ

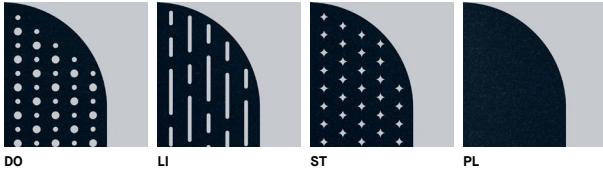

FELT FINISH FINI FEUTRE



FAMILY FAMILLE



4232

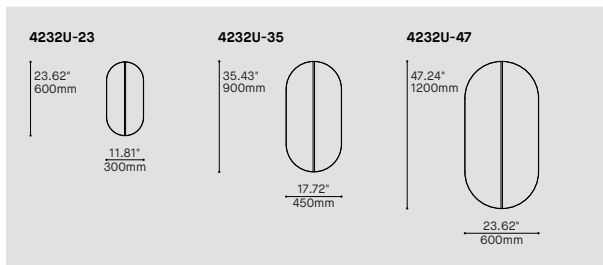

ORDERING SPECIFICATION SPÉCIFICATION DE COMMANDE

CODE

QUICKSHIP

QS5 QUICKSHIP 5 DAYS - MAXIMUM 5 UNITS QUICKSHIP 5 JOURS - MAXIMUM 5 UNITÉS
 QS10 QUICKSHIP 10 DAYS - MAXIMUM 20 UNITS QUICKSHIP 10 JOURS - MAXIMUM 20 UNITÉS

MODEL MODÈLE

4232U-23 SMALL QUADRANT UNLIT
 4232U-35 MEDIUM QUADRANT UNLIT
 4232U-47 LARGE QUADRANT UNLIT

FELT FINISH FINI FEUTRE

ABF	AZURE BLUE FELT	BYF	BANANA YELLOW FELT	REF	RED FELT
AWF	ARCTIC WHITE FELT	CHF	CHARCOAL FELT	SGF	SILVER GRAY FELT
BBF	BASIC BLACK FELT	NBF	NAVY BLUE FELT	TGF	TITANIUM GRAY FELT
BOF	BLOOD ORANGE FELT	OBF	OCEAN BLUE FELT	ZFF	ZINFANDEL FELT
BTF	BATTLESHIP GRAY FELT	PGF	PEAR GREEN FELT		

CUTOUT PATTERN MOTIF DÉCOUPÉ

DO DOTS
 LI LINES
 ST STARS
 PL PLAIN

CABLE CÂBLE

AC AIRCRAFT MOUNTING, FIELD ADJUSTABLE

AC

CABLE LENGTH LONGUEUR DE CÂBLE

60 60" AIRCRAFT CABLE (STD LENGTH)
 ** CUSTOM AIRCRAFT CABLE LENGTH (PLEASE SPECIFY)
 FOR OVERALL LENGTH, PLEASE CONTACT YOUR EUREKA REPRESENTATIVE

PRODUCT CHARACTERISTICS CARACTÉRISTIQUES DU PRODUIT



DESIGN:

Quadrant pendant highlights our discreet Mika 4230 diffuser by redefining its volume and scale. Lighted versions (4232) or the versions without light source (4232U) can be used alone or combined to create impressive layouts, while multiplying the sound absorption. Available in 3 sizes and with a variety of decorative cutout pattern made by a high precision cnc cutter.

INSTALLATION:

Installs without tool onto our pendant Mika luminaires with an ingenious crisscross assembly system. Quadrant is suspended on a clear power cable with standard or slim magnetic canopy available in white fine textured finish, with no visible fastener. Quadrant unlit is suspended on an aircraft cable without canopy.

SHADE:

The shade is composed of two rigid interlocked sound absorbing panels that increases acoustic comfort. They are made from synthetic felt composed of recycled and recyclable polyethylene (PET) fibers with low VOC, formaldehyde-free, non-irritant and odorless.

CERTIFIED:

c-CSA-us

CONCEPTION:

La suspension Quadrant met en valeur le discret diffuseur du Mika 4230 en redéfinissant son volume et son échelle. Les versions éclairées (4232) ou sans source lumineuse (4232U) peuvent s'utiliser seules ou être disposés de façon à créer d'impressionnant agencement, multipliant ainsi l'absorption du bruit ambiant. Disponible en 3 grandeurs et avec une variété de motifs décoratifs découpé par une machine CNC de haute précision.

INSTALLATION:

S'installe sans outil sur les luminaires Mika grâce à un ingénieux système d'assemblage entrecroisé. Quadrant est suspendu sur câble d'alimentation clair, sans quincaillerie visible, monté sur un pavillon magnétique standard ou mince. Le Quadrant non-éclairé est suspendu par câble d'acier sans pavillon.

ABAT-JOUR:

L'abat-jour du luminaire est composé de deux rigide panneaux insonorisant entrecroisés qui augmentent le confort acoustique. Ils sont fabriqués de feutre synthétique à base de fibres de polyéthylène (PET) recyclées et recyclables avec bas COV, sans formaldéhyde, non irritant et inodore.

CERTIFIÉ:

c-CSA-us

Acoustic Material Color Options for Quadrant



Standard colors



ABF
Azure Blue



AWF
Arctic White

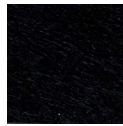

BBF
Basic Black



BOF
Blood Orange

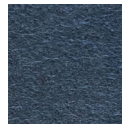

BTF
Battleship Gray



BYF
Banana Yellow



CHF
Charcoal

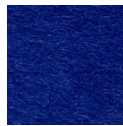

NBF
Navy Blue

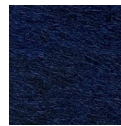

OBF
Ocean Blue

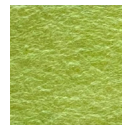

PGF
Pear Green



REF
Red



SGF
Silver Gray

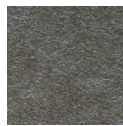

TGF
Titanium Gray

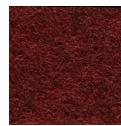

ZFF
Zinfandel

Premium colors



BGF
Bubble Gum



BKF
Bark Brown

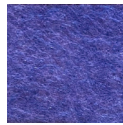

DBF
Denim Blue

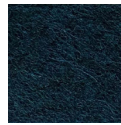

DTF
Deep Teal Green



DYF
Daisy Yellow

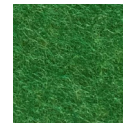

GGF
Grass Green



LBF
Light Beige

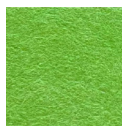

LGF
Lime Green

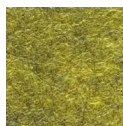

MGF
Moss Green

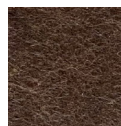

OAF
Oak Brown

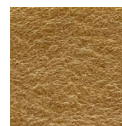

PBF
Peanut Brown



PNF
Pinot Noir

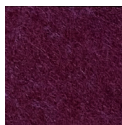

PPF
Plum Purple



SBF
Sky Blue



TOF
Tangerine Orange



TPF
Tulip Purple

- Premium colors carry extended lead times. Additional fees may apply for expedited lead times. Please consult factory.
- Due to the dye process, colors may vary slightly from batch to batch.

QUADRANT - 4232 & 4232U

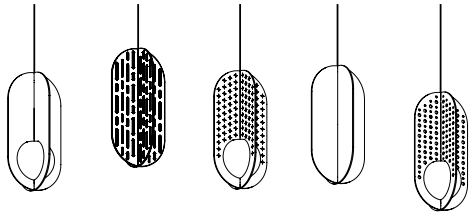

NOISE REDUCTION FIXTURES

Lighted versions (Quadrant 4232) or the versions without light source (Quadrant Unlit 4232U) can be used alone or combined to create impressive layouts, while multiplying the sound absorption.



ECOLOGICAL

Custom CNC cut polyester felt panels made from recycled bottles (PET). Panels are also recyclable.

COLORS

Available in 14 standard colors, 16 premium colors, 3 choice of pattern cutout or plain. For all options, refer to the Specification Sheet.

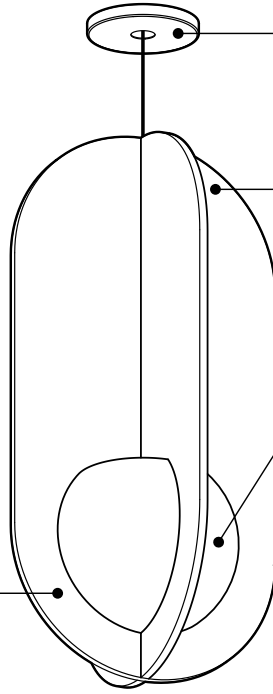

SEAMLESS INSTALLATION

Quadrant lit is suspended on a clear power cable and is available with a standard 1,35in or a slim 0,5in white magnetic canopy. Quadrant Unlit is hung on an aircraft cable without canopy.

SOUND ABSORBING SHADE

The shade is composed of two interlocked sound absorbing panels that increases acoustic comfort.

BIG FAMILY

Quadrant is available in 3 sizes, allowing a lot of configurations. Also available as an unlighted pendant (Quadrant Unlit 4232U) to reinforce the acoustic performance of a room.

CLEANING

A proper and regular cleaning will help extend the lifespan of acoustic products. Remove dust with a vacuum cleaner and light stains with a damp cloth. For greasy and deep stains, a professional dry clean is recommended. Do not use any abrasive, soap, or chemical cleaner.

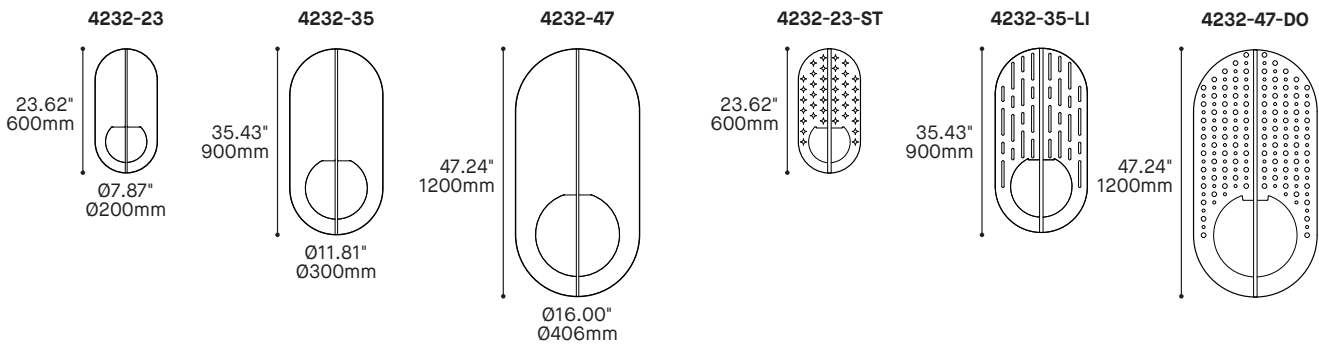

PRODUCT SPECIFICATION	4232-23	4232-35	4232-47	4232U-23	4232U-35	4232U-47
PERFORMANCE						
SYSTEM WATTAGE	9.8 W	9.8 W	14.1 W	N/A	N/A	N/A
DELIVERED LUMENS (4000K)*	916 LM	970 LM	1366 LM	N/A	N/A	N/A
<small>*EXPECT A 9% DECREASE IN PERFORMANCE FOR CHARCOAL GRAY VERSION.</small>						
OTHER INFORMATIONS						
WEIGHT	3.5LBS / 1.6KG	5.1LBS / 2.3KG	8.6LBS / 3.9KG	1.3LBS / 0.6KG	2.8LBS / 1.3KG	5.1LBS / 2.3KG
L70 (LUMEN MAINTENANCE)	> 55 000 HRS	> 55 000 HRS	> 55 000 HRS	N/A	N/A	N/A
FELT	HIGH DENSITY 9MM POLYESTER FELT					
ACOUSTIC	ACOUSTIC MATERIAL RATED AT 0.75 N					
FIRE RATING	ASTM E84-13 (FELT MATERIAL ONLY)					
WELL & LEED STANDARD REQUIREMENTS						
MAX. LUMINANCE 45°-90° OF NADIR	548 CD/M ²	235 CD/M ²	191 CD/M ²	N/A	N/A	N/A
LIGHT QUALITY	R9 > 50 (90 CRI OPTION)					
FLICKERING TOLERANCE	LOW FLICKER, COMPLIANT TO CALIFORNIA TITLE 24					

EFFICACY MULTIPLIERS

CRI	CCT	FACTOR
80+	4000K	1.00
80+	3500K	0.99
80+	3000K	0.97
80+	2700K	0.94
90+	4000K	0.89
90+	3500K	0.86
90+	3000K	0.84
90+	2700K	0.80

LIGHT DISTRIBUTION

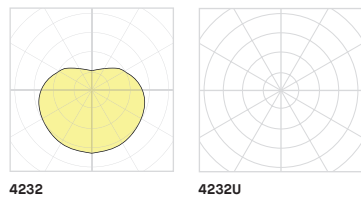

Visit our website for warranty terms and conditions.



TECHNICAL DATA

QUADRANT - 4232 & 4232U

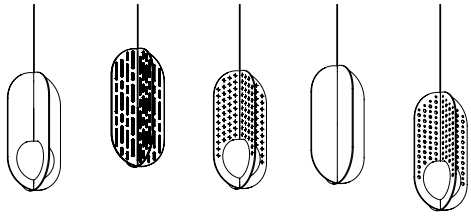

ATTÉNUATION DU BRUIT

Les versions éclairées (Quadrant 4232) ou sans source lumineuse (Quadrant Unlit 4232U) peuvent s'utiliser seules ou être disposées de façon à créer d'impressionnant agencement, multipliant ainsi l'absorption du bruit ambiant.



ÉCOLOGIQUE

Panneaux de polyester faits de bouteilles de plastique recyclées (PET) et coupés sur mesure. Les panneaux sont recyclables.

COULEURS

Disponible en 14 couleurs standards
16 couleurs Premium.
3 choix de pattern découpé ou sans.
Pour toute les options, consultez la Fiche de Spécification

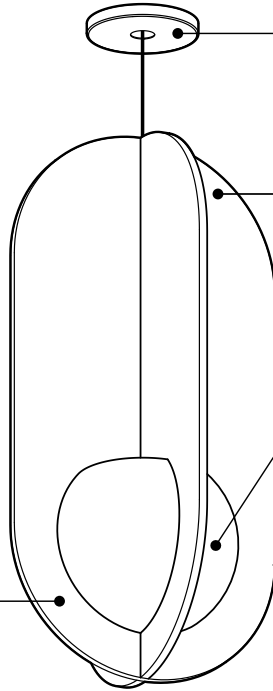

INSTALLATION SANS QUINCAILLERIE VISIBLE

Quadrant est suspendu sur câble d'alimentation clair sur un pavillon blanc magnétique standard de 1,35po ou mince de 0,5po. Quadrant Unlit est suspendu par câble d'acier sans pavillon.

ABAT-JOUR INSONORISANT

L'abat-jour du luminaire est composé de deux panneaux insonorisant entrecroisés qui augmentent le confort acoustique.

GRANDE FAMILLE DE PRODUITS

Quadrant est disponible en trois tailles, permettant de nombreuses configurations. Également disponible en suspension non éclairé (Quadrant Unlit - 4232U) pour renforcer les performances acoustiques d'une pièce.

NETTOYAGE

Un nettoyage approprié et régulier contribuera à prolonger la durée de vie des produits acoustiques. Enlever la poussière avec un aspirateur et les taches légères avec un linge humide. Pour les tâches importantes ou grassieuses, un nettoyage à sec est recommandé. Ne pas utiliser de produits abrasifs, de savon ou de produits nettoyants chimiques.

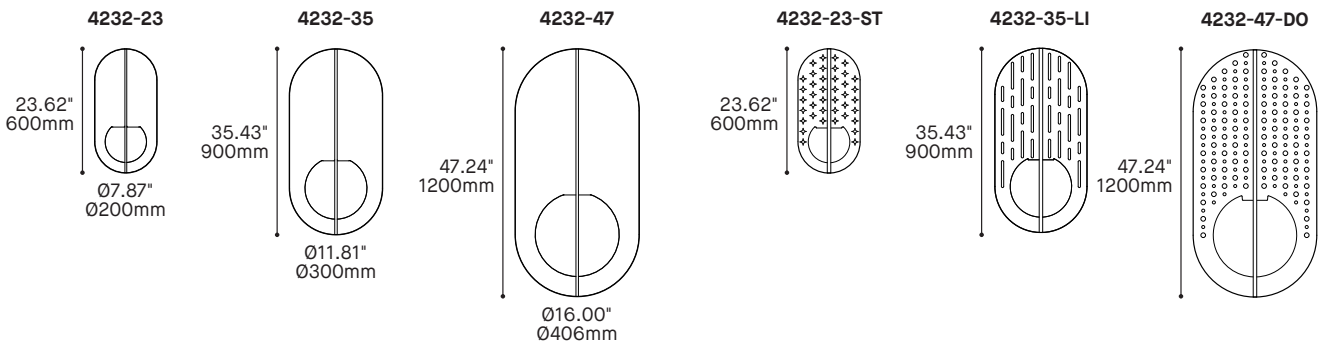

SPÉCIFICATION PRODUIT

	4232-23	4232-35	4232-47	4232U-23	4232U-35	4232U-47
PERFORMANCE						
PUISSANCE TOTALE	9.8 W	9.8 W	14.1 W	N/A	N/A	N/A
LUMENS RÉELS (4000K)	916 LM	970 LM	1366 LM	N/A	N/A	N/A
<small>*PRÉVOYEZ UNE BAISSSE DE PERFORMANCE DE 9% POUR LA VERSION GRIS CHAUD.</small>						
AUTRES INFORMATIONS						
POIDS	3.5LBS / 1.6KG	5.1LBS / 2.3KG	8.6LBS / 3.9KG	1.3LBS / 0.6KG	2.8LBS / 1.3KG	5.1LBS / 2.3KG
L70 (MAINTENANCE DE LA LUMIÈRE)	> 55 000 H	> 55 000 H	> 55 000 H	N/A	N/A	N/A
FEUTRE ACOUSTIQUE	FEUTRE DE PESTER HAUTE DENSITÉ 9MM					
RÉSISTANCE AU FEU	MATÉRIEL ACOUSTIQUE GRADÉ À 0.75 N ASTM E84-13 (MATÉRIEL FEUTRE SEULEMENT)					
CRITÈRES DE CERTIFICATION WELL & LEED						
MAX. LUMINANCE 45°-90° NADIR	548 CD/M ²	235 CD/M ²	191 CD/M ²	N/A	N/A	N/A
QUALITÉ DE LA LUMIÈRE	R9 > 50 (OPTION 90 IRC)					
TOLÉRANCE DE CLIGNOTEMENTS	PEU DE CLIGNOTEMENT (CONFORME À CALIFORNIA TITLE 24)					

FACTEUR D'EFFICACITÉ

IRC	CCT	FACTEUR
80+	4000K	1.00
80+	3500K	0.99
80+	3000K	0.97
80+	2700K	0.94
90+	4000K	0.89
90+	3500K	0.86
90+	3000K	0.84
90+	2700K	0.80

DISTRIBUTION LUMINEUSE

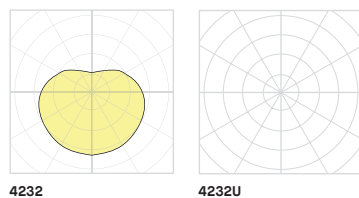

Visitez notre site Web pour les termes et conditions.



DONNÉES TECHNIQUES